ECAM38X.7Y - ECAM38X.8Y - ECAM38X.9Y

DINAMICA plus

BEAN TO CUP ESPRESSO
AND CAPPUCCINO
MACHINE
Instructions for Use

Instruction videos available at:
[https://r.delonghi.com/video/
dinamica-plus](https://r.delonghi.com/video/dinamica-plus)



DeLonghi

A

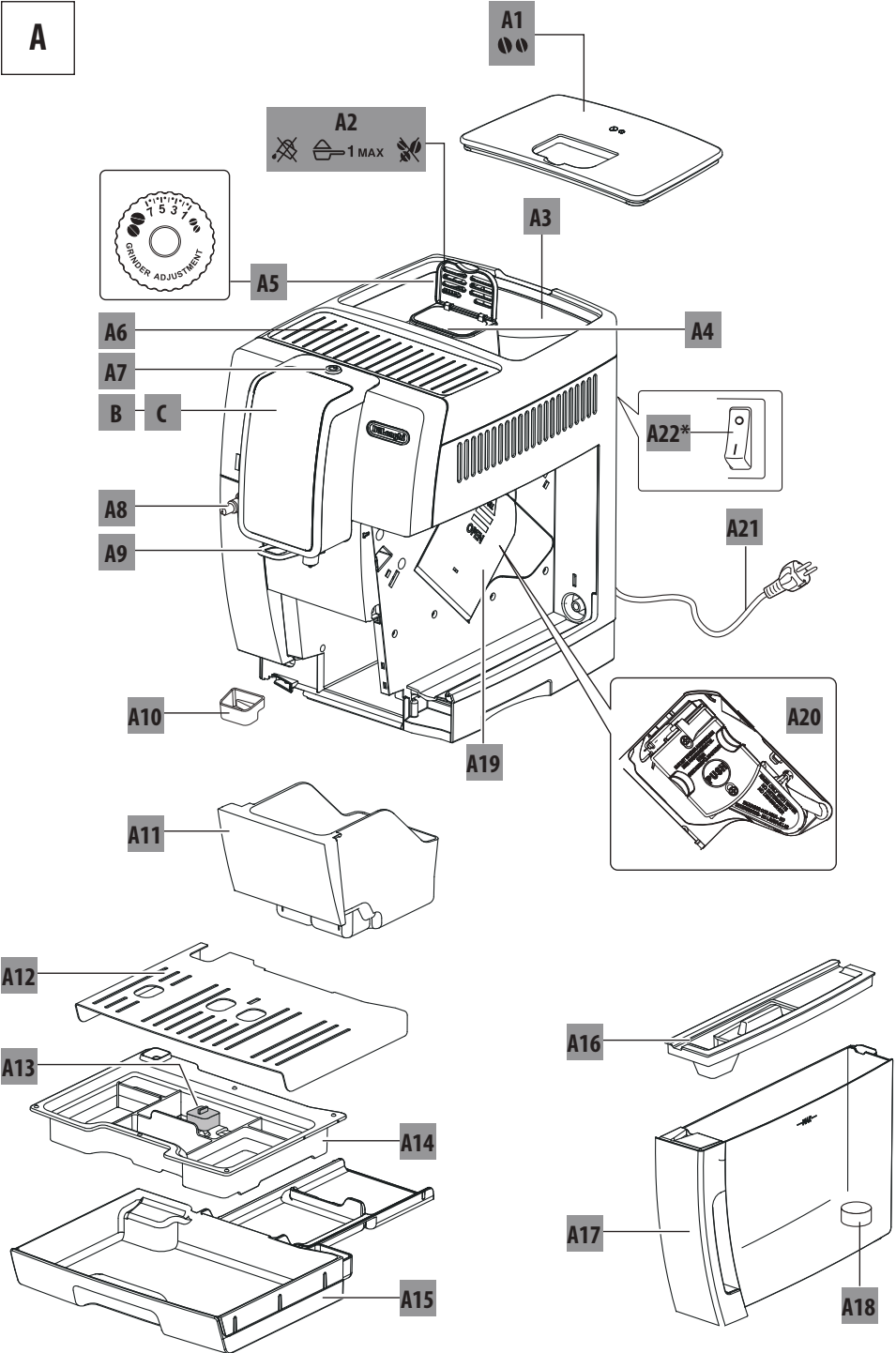

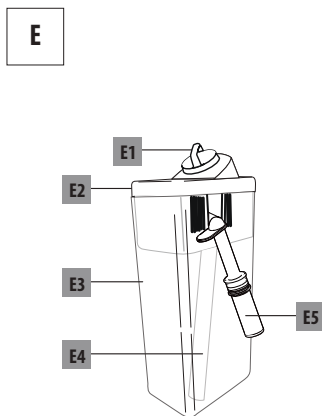
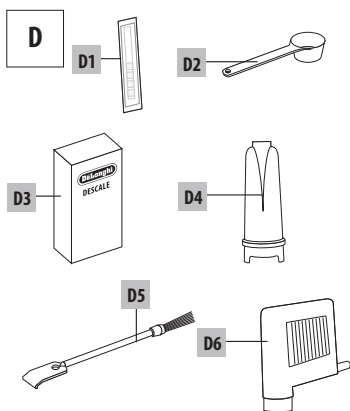
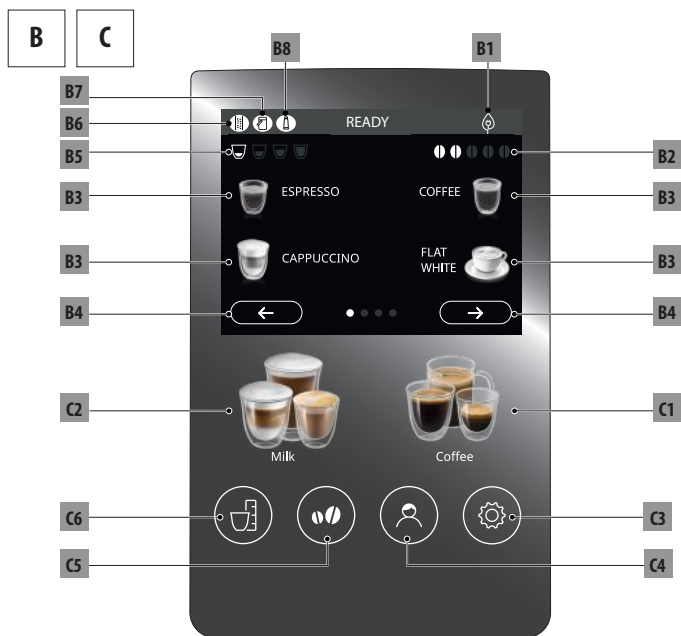

CONTENTS

1. INTRODUCTION	5
1.1 Letters in brackets	5
1.2 Troubleshooting and repairs	5
2. DESCRIPTION	5
2.1 Description of the appliance (page 2 - A)	5
2.2 Description of homepage (main screen) (page 3 - B)	5
2.3 Description of control panel (page 3 - C)	5
2.4 Description of accessories (page 3 - D)	5
2.5 Description of milk carafe (page 3 - E)	5
3. SETTING UP THE APPLIANCE	5
4. TURNING THE APPLIANCE ON	6
5. TURNING THE APPLIANCE OFF	6
5.1 Switching off for extended periods:	7
6. SETTINGS MENU	7
6.1 Access the menu	7
6.2 Exit the menu	7
6.3 Rinse	7
6.4 Descaling	7
6.5 Cleaning the carafe	7
6.6 MY programme	7
6.7 Coffee temperature	7
6.8 Drinks settings	7
6.9 Water filter	7
6.10 Water hardness	7
6.11 Auto-off (standby)	7
6.12 Set language	8
6.13 Energy saving	8
6.14 Audible warning	8
6.15 Customise profile	8
6.16 Statistics	8
6.17 Machine info	8
6.18 Default values	8
7. MAKING COFFEE	8
7.1 Making coffee using coffee beans	8
7.2 Selecting the coffee intensity	9
7.3 Selecting the coffee quantity	9
7.4 Making coffee using pre-ground coffee	9
7.5 Adjusting the coffee mill	10
7.6 Tips for a hotter coffee	10
8. COFFEE POT	10
9. MAKING HOT MILK-BASED DRINKS	11
9.2 Filling and attaching the milk carafe	11
9.3 Adjusting the amount of froth	12
9.4 Making cappuccinos and milk-based drinks automatically	12

9.5 Cleaning the milk carafe after use	12
10. DELIVERING HOT WATER	13
11. CUSTOMISING DRINKS	13
12. CLEANING	14
12.1 Cleaning the machine	14
12.2 Cleaning the internal circuit	14
12.3 Cleaning the coffee grounds container	14
12.4 Cleaning the drip tray and condensate tray	14
12.5 Cleaning the inside of the machine	15
12.6 Cleaning the water tank	15
12.7 Cleaning the coffee spouts	15
12.8 Cleaning the pre-ground coffee funnel	15
12.9 Cleaning the infuser	15
12.10 Cleaning the milk carafe	16
12.11 Cleaning the hot water nozzle	17
13. DESCALING	17
14. SETTING WATER HARDNESS	18
14.1 Measuring water hardness	18
14.2 Setting water hardness	18
15. WATER SOFTENER FILTER	19
15.1 Installing the filter	19
15.2 Replacing the filter	19
15.3 Removing the filter	20
16. TECHNICAL DATA	20
16.1 Tips for Energy Saving	20
17. DISPLAYED MESSAGES	20
18. TROUBLESHOOTING	23

1. INTRODUCTION

Thank you for choosing this bean to cup espresso and cappuccino machine.

Take a few minutes to read these Instructions for Use. This will avoid all risks and damage to the appliance.

1.1 Letters in brackets

The letters in brackets refer to the legend in the description of the appliance on pages 2-3.

1.2 Troubleshooting and repairs

In the event of problems, first try and resolve them by reading the information given in sections "17. Displayed messages" and "18. Troubleshooting".

If this does not resolve the problem or you require further information, you should consult Customer Services by calling the number given on the annexed "Customer Service" sheet.

If your country is not among those listed on the sheet, call the number given in the guarantee. If repairs are required, contact De'Longhi customer services only. The addresses are given in the guarantee certificate provided with the machine.

2. DESCRIPTION

2.1 Description of the appliance (page 2 - A)

- A1. Beans container lid
- A2. Pre-ground coffee funnel lid
- A3. Beans container
- A4. Pre-ground coffee funnel
- A5. Grinding adjustment dial
- A6. Cup shelf
- A7.  button: to turn the appliance on and off (standby)
- A8. Hot water/steam connection nozzle
- A9. Coffee spouts (adjustable height)
- A10. Condensate tray
- A11. Coffee grounds container
- A12. Cup tray
- A13. Drip tray water level indicator
- A14. Drip tray grille
- A15. Drip tray
- A16. Water tank lid
- A17. Water tank
- A18. Water softener filter housing
- A19. Infuser door
- A20. Infuser
- A21. Power cord
- A22. Main switch (certain models only)

2.2 Description of homepage (main screen) (page 3 - B)

- B1. Energy Saving active symbol
- B2. Intensity selected

- B3. Directly selected drinks
- B4. Scroll arrow
- B5. Quantity selected
- B6. Descale alarm
- B7. Milk carafe cleaning alarm
- B8. Spent filter alarm

2.3 Description of control panel (page 3 - C)

- C1. Coffee drinks menu
- C2. Milk drinks menu
- C3.  : appliance settings menu
- C4.  : profile selection menu
- C5.  : drink intensity selection
- C6.  : drink quantity selection

2.4 Description of accessories (page 3 - D)

- D1. "Total Hardness Test" strip
- D2. Pre-ground coffee measure
- D3. Descaler (certain models only)
- D4. Water softener filter (certain models only)
- D5. Cleaning brush (certain models only)
- D6. Hot water spout

2.5 Description of milk carafe (page 3 - E)

- E1. Froth adjustment and CLEAN dial
- E2. Milk carafe lid
- E3. Milk carafe
- E4. Milk intake tube
- E5. Frothed milk spout (adjustable)

3. SETTING UP THE APPLIANCE

Please note!

- The first time you use the machine, the water circuit is empty and the appliance could be very noisy. The noise becomes less as the circuit fills.
 - Coffee has been used to factory test the appliance and it is therefore completely normal for there to be traces of coffee in the mill. The machine is, however, guaranteed new.
 - You should customise water hardness as soon as possible following the instructions in section "14. Setting water hardness".
1. Plug the appliance into the mains socket and, in the case of models with main switch «A22», make sure it is set to the I position "fig. 1".

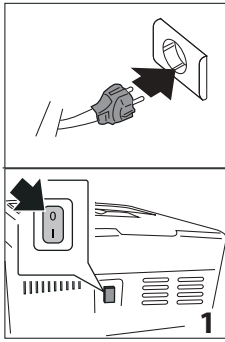

- To select the language of the display, press **Next >** and hold until the required language appears, then press the flag corresponding to the language.

Now follow the instructions indicated on the display of the appliance:

- Remove the water tank (A17) (fig. 2), fill to the MAX line (marked on the tank) with fresh water (fig. 3), then return it to its position (fig. 4);

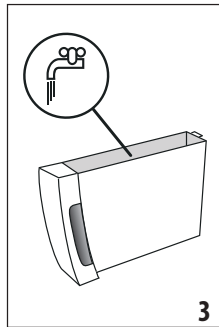
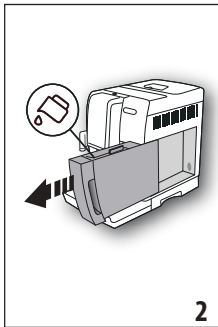

- Make sure the hot water spout (D6) is attached to the connection nozzle (A8) (fig. 5) and place a container of at least 200 ml capacity under the coffee spouts (A9) and hot water spout (fig. 6);
- Press **Ok ✓** to confirm. The appliance delivers water from the spout.
- At the end of delivery, the appliance proceeds with heating by performing a rinse cycle, delivering hot water from the coffee spouts.

The coffee machine is now ready for normal use.

Please note!

- The first time the appliance is used, it will be necessary to make 4-5 cappuccinos before the drink in the cup tastes as it should. It is normal to hear the noise of boiling water at first: the noise will become less with subsequent use.
- To improve the performance of your appliance, we recommend installing a water softener filter (D4) as described

in section "15. Water softener filter". If your model is not provided with a filter, you can request one from De'Longhi customer services.

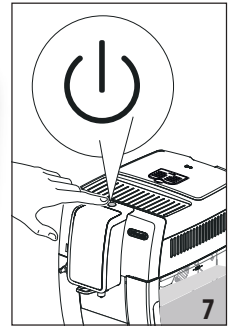
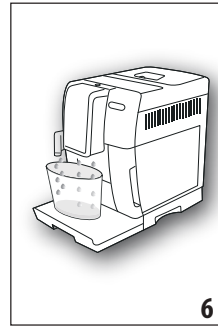
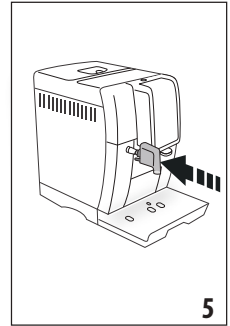
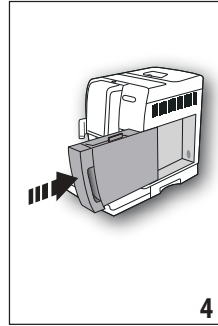

4. TURNING THE APPLIANCE ON

Please note! Models with main switch only «A22» Before turning the appliance on, make sure the main switch on the back of the appliance is pressed (fig. 1).

Each time the appliance is turned on, it performs an automatic preheat and rinse cycle which cannot be interrupted. The appliance is not ready for use until the cycle has been completed.

- To turn the appliance on, press the **⏻** button (A7)(fig. 7): the preheat sequence now starts.
- Once the appliance has heated up it performs a rinse cycle, during which hot water is delivered from the coffee spout (A9); in addition to heating up the boiler, this also heats the internal circuits by circulating hot water.

The appliance is ready for use when the main screen (homepage) appears.

5. TURNING THE APPLIANCE OFF

Whenever the machine is turned off after being used to make coffee, it performs an automatic rinse cycle.

Danger of scalding!

During rinsing, a little hot water flows from the coffee spouts (A9) . Take care to avoid contact with splashes of water. To

avoid the need for frequent emptying of the drip tray , place a container under the spouts to collect the rinse water.

1. To turn the appliance off, press the  button (A7) (fig. 7).
2. If provided for, the appliance performs a rinse cycle then goes off (stand-by).

5.1 Switching off for extended periods:

If the machine is not going to be used for any length of time (e.g. holidays, periods of absence), proceed as follows:

- turn the appliance off by pressing the  button (fig. 7);
- empty out and clean the grounds container (A11) and the water tank (A17);
- unplug the power cord (A7) from the socket.

Please note:



When turning the machine on again, fill the water tank and, before making any kind of drink, run 3 rinse cycles as indicated in section "6.3 Rinsing."

Important!

Always turn the appliance off with the  button (standby) or, in the case of models having a main switch, set the switch to the 0 position, before unplugging from the mains socket.

6. SETTINGS MENU

6.1 Access the menu

1. Press the  button (C3) to enter the menu;
2. Scroll through the menu items by pressing  until the required item is displayed;
3. Press the menu item you want to select.

6.2 Exit the menu

Having made the desired adjustments, press  Esc until the homepage reappears.

6.3 Rinse

Use this function to deliver hot water from the coffee spouts (A9) to clean and heat the appliance's internal circuit.

1. Place a container of at least 100ml capacity under the coffee spouts (fig. 8).
2. A few seconds after "RINSE" has been selected, hot water is delivered from the coffee spouts to clean and heat the appliance's internal circuit (fig. 8).
3. To stop rinsing, press  or wait for rinsing to stop automatically.

Please note

After cleaning, it is normal for the grounds container (A11) to contain water.

6.4 Descaling

For instructions on descaling, see section "13. Descaling".

6.5 Cleaning the carafe

For instructions on cleaning the milk carafe (E3), see section "15. Water softener filter".

6.6 MY programme

Pressing the  button, users can choose under which profile to customize their drink (see section "11. Customizing drinks").

6.7 Coffee temperature

To change the temperature of the water used to make the coffee, proceed as follows:







1. Press "COFFEE TEMPERATURE". The selectable values appear on the display (the current value is underlined);
2. Press the value you want to set (LOW, MEDIUM, HIGH).

Please note:

Varying the temperature has most effect for long drinks.

6.8 Drinks settings

In this section, you can consult your customised settings and, if you wish, reset the default values for each drink.

1. Once in the settings menu, press "DRINK SETTINGS". The values for the first drink appear on the display;
2. The values are displayed on vertical bars. The default value is indicated by the  symbol, while the current value is highlighted by the solid part of the vertical bar;
3. To scroll and display the drinks, press  ;
4. To reset the default values for the drink displayed, press  ;
5. "CONFIRM RESET?": to confirm, press  (to cancel, press  Esc);
6. "'DEFAULT VALUES SET?": press .

The drink has been reset to the default values. Proceed with the other drinks or go back to the homepage by pressing  Esc twice.

6.9 Water filter

For instructions on how to install the filter (D4), see section "15. Water softener filter".

6.10 Water hardness

For instructions on setting water hardness, see section "14. Setting water hardness".

6.11 Auto-off (standby)

Auto-off can be set so that if the appliance is not being used, it will switch off after 15 or 30 minutes or after 1 or 3 hours have elapsed.

To programme Auto-off, proceed as follows:

1. Press "AUTO-OFF";

- Select the required time interval by pressing the selection arrows (▲) (increase) or (▼) (decrease);
- To confirm, press (Ok ✓).
Auto-off is now programmed.

6.12 Set language

To modify the language of the display, proceed as follows:

- Press "SET LANGUAGE";
- Press the flag corresponding to the language you want to set (press (Next >) to display all the languages available).

6.13 Energy saving

Use this function to enable or disable energy saving. When enabled, the function reduces energy consumption in compliance with European regulations.

To disable or enable "Energy Saving", proceed as follows:

Press "ENERGY SAVING" to disable (OFF) or enable (ON) the function;

The corresponding symbol (B1) appears on the top bar of the homepage to indicate that the function has been enabled.

Please note:

If energy saving is active, you may have to wait a few seconds before delivery.

6.14 Audible warning

This enables or disables the beep emitted by the machine each time an icon is pressed or an accessory is inserted/removed. To disable or enable the beep, proceed as follows:

- Press "BEEP" to disable (OFF) or enable (ON) the function;

6.15 Customise profile

To customise the icon of the current profile, proceed as follows:

- Press "CUSTOMISE PROFILE";
- Select the desired icon (press (Next >) to display all the available icons).

6.16 Statistics

This displays statistics relating to the machine. To view the statistics, proceed as follows:

Press "STATISTICS" and check all the statistics by scrolling through the items using (Next >).

6.17 Machine info

This displays the serial number of the machine. To view the number, press "MACHINE INFO". (press (Esc ↵) to cancel the operation).

6.18 Default values

This function resets all menu settings and all user customizations, restoring the factory default values (with the exception of the language, which remains as set, and the statistics).

To reset the default values, proceed as follows:

- Press "DEFAULT VALUES": the display shows the prompt "RESET FACTORY DEFAULT VALUES": press (Ok ✓) to confirm (or press (Esc ↵) to cancel the operation);
- "FACTORY DEFAULT VALUES SET": press (Ok ✓) to confirm.

7. MAKING COFFEE

7.1 Making coffee using coffee beans

Important!

Do not use green, caramelized or candied coffee beans as they could stick to the coffee grinder and make it unusable.

- Fill the container (A3) with coffee beans (fig. 9);

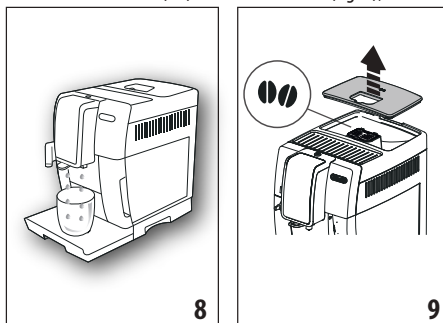

- Place a cup under the coffee spouts (A9) (fig.8);
- Lower the spouts as near as possible to the cup (fig. 10).
This makes a creamier coffee;
- Select the required coffee drink:

Recipe	Quantity	Program- mable quantity	Intensity predefined
ESPRESSO	≈ 40 ml	from ≈ 20 to ≈ 180ml	● ● ● ● ●
COFFEE	≈ 180 ml	from ≈ 100 to ≈ 240ml	● ● ● ● ●
LONG	≈ 160 ml	from ≈ 115 to ≈ 250 ml	● ● ● ● ●
2X ESPRESSO	≈ 40 ml x 2 cups	--	● ● ● ● ●

ESPRESSO LUNGO	≈ 120 ml	≈ 20 -180 ml	
SHORT	≈ 30 ml	≈ 20-40 ml	
DOPPIO+	≈ 120 ml	≈ 80-180 ml	
COFFEE POT	≈ 250 ml	-	
ICED COFFEE	≈ 100 ml	-	-
VERLÄNGERTER	≈ 80 ml	≈ 50-480 ml	
AMERICANO	≈ 150 ml	≈ 70- 480 ml	
HOT WATER	≈ 250 ml	≈ 20-420 ml	-

5. Preparation begins. An image of the selected drink appears on the display, together with a progress bar which gradually fills as preparation progresses.

Please note:

- Press on the scroll arrows (Next >) to view all drinks.
- You can prepare 2 cups of ESPRESSO coffee at the same time by pressing "2X" during preparation of 1 ESPRESSO (the image is displayed for a few seconds at the start of preparation).
- While the machine is making coffee, delivery can be interrupted at any moment by pressing (Stop X).
- Immediately following delivery, to increase the quantity of coffee delivered, press (Extra +) : when the required quantity is reached, press (Stop X) or (Esc).

Once the preparation has been completed, the machine is ready for use again.

Please note!

- Various alarm messages could be displayed while using the appliance (FILL TANK, EMPTY GROUNDS CONTAINER, ETC.). Their meaning is explained in section "17. Displayed messages".
- For hotter coffee, see section "7.6 Tips for a hotter coffee".
- If the coffee emerges drop-by-drop, too weak and not creamy enough, or too cold, read the tips in section "7.5 Adjusting the coffee mill" and in section "18. Troubleshooting".
- Preparation of each coffee can be customised (see section "11. Customising drinks").

7.2 Selecting the coffee intensity

Press the button (C5):

my	Predefined or programmed intensity
	EXTRA LIGHT
	LIGHT
	MEDIUM
	STRONG
	X-STRONG
	(see "7.4 Making coffee using pre-ground coffee")

After delivering the drink, the intensity setting is reset to the my value.

7.3 Selecting the coffee quantity

Press the button (C6):

my	Predefined or programmed quantity (see table in section "11. Customising drinks")
	SMALL SIZE
	MEDIUM SIZE
	LARGE SIZE
	X-LARGE SIZE

After delivering the drink, the quantity setting is reset to the my value

7.4 Making coffee using pre-ground coffee

Important!

- Never add pre-ground coffee when the machine is off, or it could spread through and soil the inside of the machine. This could damage the machine.
 - Never use more than 1 level measure (D2) as it could soil the inside of the coffee machine or block the funnel (A4).
- D1. When using pre-ground coffee, only one cup can be made at a time.
1. Press the button (C5) repeatedly until the message "☞" (pre-ground) is displayed.
 2. Select the required coffee drink:
 - ESPRESSO

- LONG
 - COFFEE
 - 2X ESPRESSO
 - ESPRESSO LUNGO
 - SHORT
 - DOPPIO+
 - VERLÄNGERTER
 - AMERICANO
3. "ADD GROUND COFFEE MAX. ONE MEASURE": open the lid of the pre-ground coffee funnel (A2).
 4. Make sure the funnel (A4) is not blocked, then add one level measure of pre-ground coffee (fig. 11).

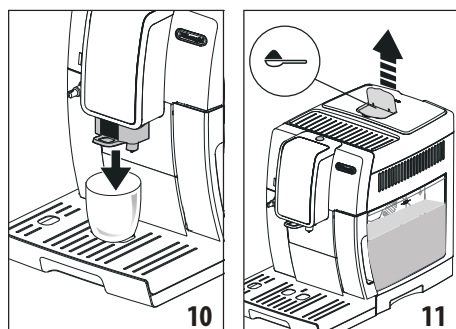
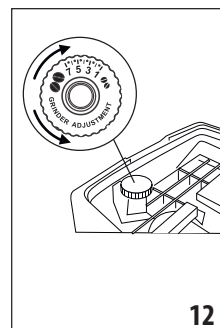

5. Place a cup under the coffee spouts (A9) (fig. 10).
6. Press **Ok ✓**: preparation begins. An image of the selected drink appears on the display, together with a progress bar which gradually fills as preparation progresses. Once the preparation has been completed, the machine is ready for use again.

Important! Making LONG coffee:

Halfway through preparation, the machine requests a further level measure of pre-ground coffee. Proceed, then press **Ok ✓**.

7.5 Adjusting the coffee mill

During the initial stages of use, there is no need to adjust the coffee mill as the factory setting will ensure that the coffee is brewed correctly.

However, if after the initial period of use coffee emerges either too weak or not creamy enough, or the delivery is too slow (drop by drop), this can be corrected by adjusting the grinding adjustment dial (A5) (fig. 12).

Please note!

The adjustment dial must be turned only when the coffee mill is in operation during the initial step of coffee preparation.

If the coffee is delivered too slowly or not at all, turn one click clockwise towards 7. For fuller bodied creamier coffee, turn one click anticlockwise towards 1 (do not turn more than one click at a time otherwise the coffee could be delivered a drop at a time).

The effect of the adjustment will be noticed only after making a further 2 cups of coffee, at least. If this adjustment does not produce the desired result, turn the dial another click.

7.6 Tips for a hotter coffee

To make a hotter coffee, proceed as follows:



- run a rinse cycle by selecting the "Rinse" function (section "6.3 Rinse ☺");
- warm the cups with hot water using the hot water function (see section "10. Delivering hot water");
- increase the coffee temperature setting (section "6.7 Coffee temperature ☺"). Varying the temperature is most effective with long drinks.

8. COFFEE POT



Based on espresso coffee, the recipe of this drink is light and balanced, featuring a finely frothed top, ideal to share in company.

Optional accessory in certain models:	
	Coffee Pot (Capacity: 750ml)
	Model: AS00006179
	EAN: 8004399333642

To make the drink, proceed as follows:

N° cups selected	Quantity (ml) *
	≈ 250
	≈ 500
	≈ 750

(*) The quantities indicated are approximate and may vary according to the type of coffee.

1. Press "COFFEE POT";
2. Select the intensity and the number of cups;
3. Press  to move on to the next step.
4. "FILL TANK AND BEANS CONTAINER": fill the water tank (A17) and the beans container (A3) (fig. 9) as indicated on the display. Make sure there is sufficient water and coffee for the drinks to be prepared, then press .
5. "PLACE POT UNDER SPOUTS". Position a pot under the coffee spouts (A9): when choosing the pot to use, bear in mind the quantity to be delivered.
6. Press : After a few seconds, preparation begins automatically and an image of the selected drink appears on the display, together with a progress bar which gradually fills as preparation progresses.

Once the preparation has been completed, the machine is ready for use again.

Please note:

-  Esc : press to interrupt preparation completely and go back to the homepage.

SAFETY WARNING:

After making a pot of coffee, leave the machine to cool for 5 minutes before making another drink. Risk of overheating!

9. MAKING HOT MILK-BASED DRINKS

Please note!

To avoid the preparation of milk with poor froth or large bubbles, always clean the milk container lid (E2) and hot water connection nozzle (A8) as described in sections "9.5 Cleaning the milk carafe after use", "12.10 Cleaning the milk carafe" and "12.11 Cleaning the hot water nozzle".

9.1 Which milk to use?

The quality of the froth will vary depending on:

- the temperature of the milk or vegetable drink used (for best results, always use milk or vegetable drink straight from the fridge + 5°C);
- type of milk or vegetable drink;
- the brand used;
- ingredients and nutritional values.

Cow's milk	
Whole (fat >3,5%)	✓
Semi-skimmed (fat between 1.5 and 1.8%)	
Skimmed (fat <0.5%)	
Vegetable drinks	
Soya	✓
Almond	✓
Oatmeal	✓

9.2 Filling and attaching the milk carafe

1. Remove the lid (E2) (fig. 13);
2. Fill the milk carafe (E3) with a sufficient quantity of milk, not exceeding the MAX level marked on the carafe (fig. 14). Each mark on the side of the carafe corresponds to about 100 ml of milk;



Please note!

- For a denser and more evenly distributed froth, always use skimmed or partially skimmed milk at refrigerator temperature (about 5 °C).
 - If "Energy Saving" mode is enabled (see section), there may be a delay of a few seconds before the drink is delivered.
3. Make sure the milk intake tube (E4) is secured correctly to the socket on the underside of the milk carafe lid (fig. 15);

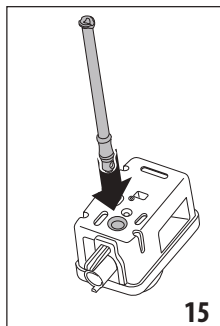
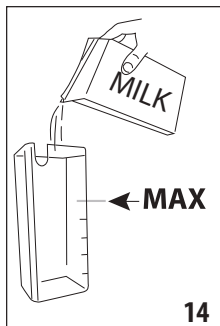

4. Reposition the lid on the milk carafe;
5. Remove the hot water spout (D6);
6. Attach the milk carafe (E) to the connection nozzle (A8) and push fully home (fig. 16). The machine emits a beep (if the beep function is enabled);
7. Place a sufficiently large cup under the coffee spouts (A9) and the frothed milk spout (E5). Adjust the length of the milk spout. To move it nearer the cup, simply pull it downwards (fig. 17).

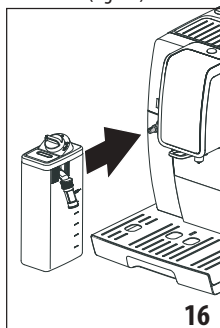

8. Follow the instructions below for each function.

9.3 Adjusting the amount of froth

Turn the froth adjustment dial (E1), to adjust the amount of froth on the milk delivered when making cappuccinos and other milk-based drinks.

Dial position	Description	Recommended for...
	DELICATE	HOT MILK (not frothed) / CAFFELATTE/ CAFE' CON LECHE / CAFE' AU LAIT
	CREAMY	LATTE MACCHIATO/ FLAT WHITE / CORTADO

	DENSE	CAPPUCCINO / CAPPUCCINO+ / CAPPUCCINO MIX / ESPRESSO MACCHIATO / HOT MILK (frothed)
--	-------	---

9.4 Making cappuccinos and milk-based drinks automatically

1. Fill the milk carafe (E) and attach it as described above.
2. Select the required drink:
 - CAPPUCCINO
 - LATTE MACCHIATO
 - HOT MILK
 - CAPPUCCINO+
 - CAPPUCCINO MIX
 - CAFFELATTE
 - FLAT WHITE
 - ESPRESSO MACCHIATO
 - CAFE' CON LECHE
 - CAFE' AU LAIT
 - CORTADO
 - GALAO
3. A message on the display recommends setting the froth adjustment dial (E1) according to the froth required by the original recipe: turn the dial on the lid of the milk carafe.
4. After a few seconds, preparation begins automatically and an image of the selected drink appears on the display, together with a progress bar which gradually fills as preparation progresses.

Once the preparation has been completed, the machine is ready for use again.

Please note! general indications when preparing all milk-based drinks

- Esc : press to stop preparation completely and go back to the homepage.
- Stop X : press to interrupt milk or coffee delivery and move on to the next delivery (if applicable) to complete the drink.
- Preparation of each milk-based drink can be customized (see section "11. Customising drinks").
- Do not leave the milk container out of the refrigerator for long periods; the warmer the milk (5 °C is ideal), the poorer the quality of the froth will be.

9.5 Cleaning the milk carafe after use

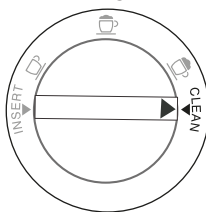

Every time that milk functions are used, the message "TURN ADJUSTMENT DIAL TO CLEAN POSITION" appears on the display and the lid of the milk carafe must be cleaned:

1. Leave the milk carafe in the machine (there is no need to empty the carafe);
2. Place a cup or other recipient under the frothed milk spout;
3. Turn the froth adjustment dial (E1) to "CLEAN" (fig. 18). "CLEANING UNDERWAY RECIPIENT UNDER SPOUT" appears on the display together with a bar which gradually fills as cleaning progresses. Steam mixed with hot water comes out of the frothed milk spout (fig. 19). Cleaning stops automatically;

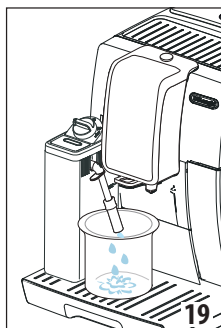
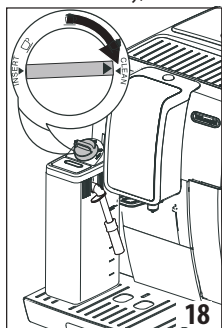

4. Turn the dial back to one of the froth selections;
5. Remove the milk carafe and always clean the hot water connection nozzle (A8) with a sponge (fig. 20).

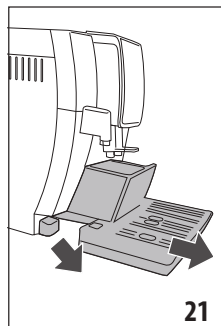

Where various drinks are prepared in succession:

- Proceed with cleaning of the carafe after the final preparation.

After multiple preparations, the milk carafe is empty or the milk that remains is not enough to make further drinks

- Having carried out the cleaning step with the froth adjustment dial (E1) set to the "CLEAN" position, disassemble the milk carafe and clean all components, proceeding as described in heading "12.10. Cleaning the milk carafe"

After multiple preparations, there is enough milk left in the carafe to make further drinks

- Having carried out the cleaning step with the froth adjustment dial (E1) set to the "CLEAN" position, remove the milk

carafe, return it straight away to the fridge and clean all components, proceeding as described in heading "12.10. Cleaning the milk carafe"

Following preparation of milk-based drinks — general notes:

- If the milk carafe is left out of the refrigerator for more than 30 minutes, disassemble and clean all components, proceeding as described in section "12.10. Cleaning the milk carafe".
- the carafe cannot be kept in the refrigerator for more than 2 days.
- If the milk carafe is not cleaned, the  symbol (B7) appears on the display as a reminder that cleaning is required.
- In certain cases, the machine will need to heat up before cleaning can take place.

10. DELIVERING HOT WATER

1. Make sure the hot water spout (D6) is attached correctly to the hot water connection nozzle (A8);
2. Place a cup under the spout;
3. Press "HOT WATER"; The corresponding image appears on the display, together with a progress bar which fills gradually as preparation proceeds;
4. The machine delivers hot water, then delivery stops automatically. To interrupt hot water delivery manually, press .



Please note!

- If "Energy Saving" mode is active, there may be a delay of a few seconds before the hot water is delivered.
- Preparation of hot water can be customised (see section "11. Customising drinks").

11. CUSTOMISING DRINKS

The intensity (when required) and the quantity of drinks can be customised.

To access the function, press the  button (C3). Scroll the menu and select .

1. Select the required profile;
2. Select the drink to be customise: the requisite accessories must be fitted;
3. For coffee drinks only, select the required intensity by pressing "-" or "+" then press .
4. Preparation begins and the display shows the drink with a vertical bar. The star alongside the bar represents the current quantity;
5. When the amount reaches the minimum programmable quantity, the message  will be displayed;
6. Press  when the required quantity in the cup is reached;

7. Press **Ok ✓** to save (or **Esc** to cancel). The appliance confirms if the values have been saved or not (depending on the previous selection). Press **Ok ✓**. The appliance goes back to the homepage.

Please note!

- **Milk-based drinks:** the intensity of the coffee is saved first, followed by the quantity of milk, then the quantity of coffee;
- **Hot water:** the appliance delivers hot water. Press **Stop X** to save the required quantity.
- Press **Esc** to exit programming. The values will not be saved.

12. CLEANING



12.1 Cleaning the machine

The following parts of the machine must be cleaned periodically:

- internal circuit;
- coffee grounds container (A11);
- drip tray (A15), condensate tray (A10), drip tray grille (A14) and tray full indicator (A13);
- water tank (A17);
- coffee spouts (A9);
- pre-ground coffee funnel (A4);
- infuser (A20), accessible after opening the infuser flap (A19);
- milk carafe (E);
- hot water connection nozzle (A8);
- control panel (C).

Important!

- Do not use solvents, abrasive detergents or alcohol to clean the machine. With De'Longhi superautomatic coffee machines, no chemical additives are required for cleaning purposes.
- None of the components of the appliance can be washed in a dishwasher: the only exceptions are the drip tray grille (A14), the milk carafe (E) and the drip tray (A15).

dishwasher safe	hand wash only
	
drip tray grille (A14)	cup tray (A12)
Milk carafe (E)	water tank (A17)
drip tray (A15)	removable infuser (A20)
	coffee grounds container (A11)

- Do not use metal objects to remove encrustations or coffee deposits as they could scratch metal or plastic surfaces.

12.2 Cleaning the internal circuit

If the appliance is not used for more than 3/4 days, it is strongly advisable when switching on again, before using it, to empty the water and fill it with fresh drinking water, then run 2/3 rinse cycles selecting the "Rinse" function (section "6.3 Rinse ☺");

Please note!

Water may find its way into the grounds container (A11) during the above rinse procedure: this is quite normal.

12.3 Cleaning the coffee grounds container

When "EMPTY GROUNDS CONTAINER" appears on the display, the grounds container must be emptied and cleaned. Until the the grounds container (A11) is repositioned, the machine cannot make coffee. Even if the grounds container is not full, the "Empty" warning message will be displayed 72 hours after the first coffee has been prepared. For the 72 hours to be calculated correctly, the machine must never be turned off with the main switch (A22) (if the model has one).

Important! Danger of scalding

If several milk-based drinks are prepared one after the other, the metal cup tray (A12) becomes hot. Wait for it to cool down before touching it and handle it from the front only.

To clean (with the machine on):

1. Remove the drip tray (A15) and the grounds container (A11)(fig. 21).
2. Empty the drip tray and grounds container and clean thoroughly to remove all residues left on the bottom. This can be done using the spatula on the brush (D5) provided.
3. Check the condensate tray (A10) (colour red) and empty if necessary.
4. Put the drip tray complete with grille and grounds container back in the appliance.

Important!

When removing the drip tray, the coffee grounds container must always be emptied, even if it has not filled up noticeably. If this is not done, it can happen that when further coffees are prepared, the grounds container will fill up more than expected and clog the machine.

12.4 Cleaning the drip tray and condensate tray

Important!

The drip tray (A15) is fitted with a level indicator (A13) (colour red) showing the amount of water it contains (fig. 22). Before the indicator protrudes from the cup tray, the drip tray (A12) must be emptied and cleaned, otherwise the water may overflow the edge and damage the appliance, the surface it rests on or the surrounding area.

To remove the drip tray, proceed as follows:

1. Remove the drip tray and the coffee grounds container (A11) (fig. 21);
2. Remove the cup tray (A12) and drip tray grille (A14), then empty the drip tray and grounds container and wash all components.
3. Check the condensate tray, (A10) coloured red, and empty if necessary;
4. Put the drip tray, complete with grille, tray and grounds container, back in the appliance.

Important!

When removing the drip tray, the coffee grounds container must always be emptied, even if it has not filled up noticeably. If this is not done, it can happen that when further coffees are prepared, the grounds container will fill up more than expected and clog the machine.

12.5 Cleaning the inside of the machine

Danger of electric shock!

Before cleaning internal parts, the machine must be turned off (see section "5. Turning the appliance off") and unplugged from the mains power supply. Never immerse the machine in water.

1. Check periodically (about once a month) that the inside of the appliance (accessible after removing the drip tray) and the coffee grounds container (A15) are not dirty. If necessary, remove coffee deposits with the brush (D5) supplied and a sponge.
2. Remove all residues with a vacuum cleaner (fig. 23).

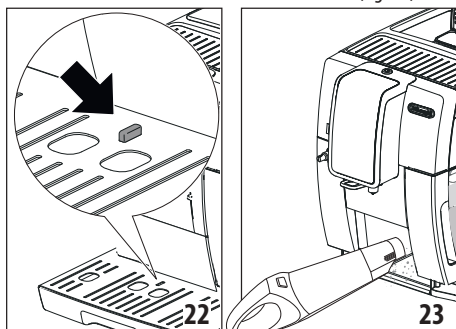

3. Put the drip tray, complete with grille, tray and grounds container, back in the appliance

12.6 Cleaning the water tank

Periodically (about once a month) and whenever the water softener filter (D4) is replaced (if installed), be sure to clean the water tank (A17).

1. Remove the water tank (fig. 2);
2. Remove the filter (if installed) and rinse with running water;

3. Empty the water tank and clean with a damp cloth and a little washing up liquid. Rinse thoroughly with water.
4. Reinstall the filter (if installed, fill the tank with fresh water up to the MAX level and reposition the tank;
5. (Models with water softener filter only) Release around 100ml of hot water to reactivate the filter.

Please note:

If the appliance is not used for more than 3-4 days, it is advisable to clean the tank as described above.

12.7 Cleaning the coffee spouts

1. Clean the coffee spouts (A9) periodically with a sponge or cloth (fig. 24A);
2. Check that the holes in the coffee spout are not blocked. If necessary, remove coffee deposits with a toothpick (fig. 24B).

12.8 Cleaning the pre-ground coffee funnel

The pre-ground coffee funnel (A4) requires cleaning periodically (about once a month). Proceed as follows:

1. Turn the machine off (see section "5. Turning the appliance off");
2. Open the funnel flap (A2);
3. Clean the funnel with the brush provided (D5) (if included);
4. Close the flap.

Important!

After cleaning, make sure that no object or accessory has been left in the funnel: the presence of foreign matter in the funnel during operation could cause damage to the machine.

12.9 Cleaning the infuser

The infuser (A20) must be cleaned at least once a month.

Important!

The infuser cannot be removed while the machine is on.

1. Make sure the procedure for turning off the machine has been completed correctly off (see section "5. Turning the appliance off");
2. Remove the water tank (A17) (fig. 2);
3. Open the flap (A19) (fig. 25) on the right hand side;

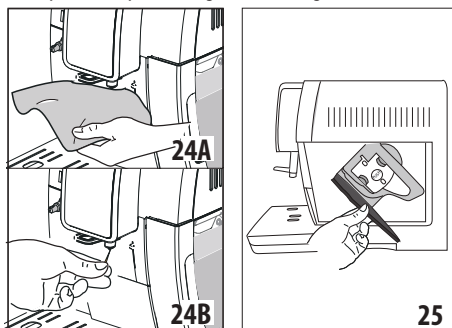

- Press the two coloured release buttons inwards and at the same time pull the infuser outwards (fig. 26);
- Immerse the infuser in water for about 5 minutes, then rinse under the tap;

Important!

RINSE WITH WATER ONLY
NO DETERGENTS - NO DISHWASHER

- Do not use detergents when cleaning the infuser, as they could damage it.
- Use the brush (D5) (if included), to remove any coffee residues left in the infuser housing, visible behind the infuser flap (A19);
- After cleaning, replace the infuser by sliding it into its housing (fig. 27), then apply pressure to the PUSH symbol until it clicks into place;

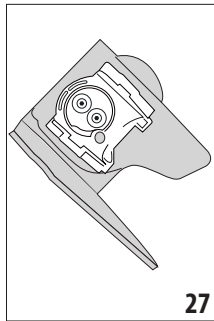
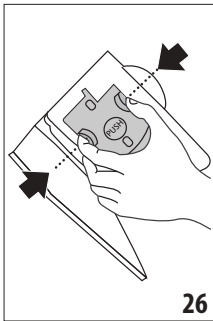

Please note!

If the infuser is difficult to insert, before insertion, adapt it to the right size by pressing the two levers shown in fig. 28.

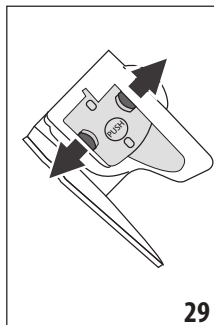
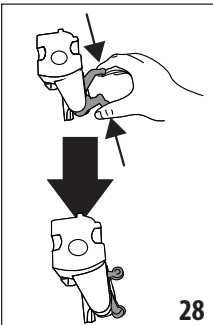

- Once inserted, make sure the two coloured buttons have snapped out (fig. 29);
- Close the infuser flap;
- Reposition the water tank in the machine.

12.10 Cleaning the milk carafe

Clean the milk carafe (E) after each use, as described below:

- Remove the lid (E2);

- Remove the milk spout and extension (E5), and the intake tube (E4) (fig. 30);
- Turn the froth adjustment dial (E1) anticlockwise to the "INSERT" position (fig. 31) and pull off upwards;

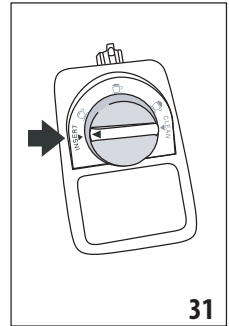
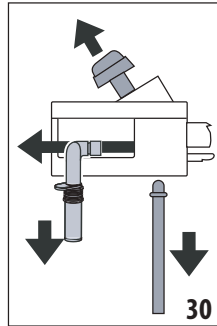

- Wash in a dishwasher (recommended) or by hand as indicated below:
 - In a dishwasher:** Rinse all the above components and the milk carafe under hot running drinking water (at least 40 °C), then place them in the top basket of the dishwasher and run a wash programme at 50 °C, e.g. standard ECO.
 - By hand** Rinse all the components and the milk carafe thoroughly with hot running drinking water (at least 40 °C) to remove all visible milk residues; make sure to direct the water through the holes in the lid (fig. 32A). Then immerse all the components in hot drinking water (at least 40 °C) and washing up liquid for at least 30 minutes. Rinse all the components described above thoroughly under hot drinking water, rubbing each one individually between fingers and thumbs.

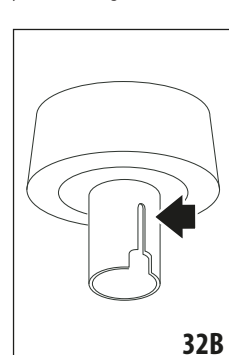
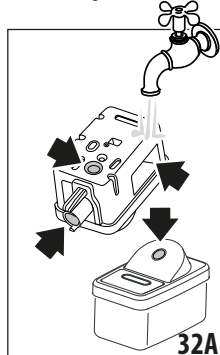

- Make sure that there are no milk residues left in the recess and the channel on the underside of the dial: if necessary, scrape the channel clean with a toothpick (fig. 32B);
- Check that the intake tube and spout are not clogged with milk residues;
- Dry all the components with a clean dry cloth;
- Reassemble all the lid components;

9. Refit the lid to the milk carafe.

Please note:

The machine will give a reminder each week of the need for thorough cleaning of the milk carafe, indicating the correct procedure.

12.11 Cleaning the hot water nozzle

Clean the nozzle (A8) every time that milk is prepared, using a sponge to remove milk residues from the gaskets (fig. 20).

13. DESCALING

Important!

- Before use, read the instructions and the labelling relative to the descaler product, which are indicated on the pack (included with certain models and/or available for purchase from authorized service centres).
- Use De'Longhi descaler only. Using unsuitable descaler and/or performing descaling incorrectly may result in faults not covered by the manufacturer's guarantee.
- Descaler can damage delicate surfaces. If the product is accidentally spilt, dry immediately.

To descale	
Descaler	De'Longhi "EcoDecalk" descaler
Container	Recommended capacity: 2.0 litres
Time	~30min

Descale the appliance when "DESCALING NEEDED - PRESS OK TO START (~30min) appears on the display": To descale the appliance immediately, press **Ok ✓** and follow the operations from point 3.

To delay descaling until later, press **↶ Esc**. The symbol  (B6) appears on the display as a reminder that the appliance needs descaling. (The message reappears every time the machine is turned on).

To access the descaling menu:

1. Press the  button (C3) to enter the menu;
2. Press "DESCALE" and follow the instructions on the display;

3. "REMOVE WATER FILTER" (fig. 33): take out the water tank (A17), and remove the water softener filter (D4) (if present).

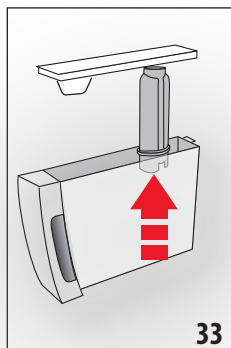

ent).

4. Empty the water tank. Press **Next >** ;
5. "DESCALER (LEVEL A) AND WATER (LEVEL B)": Pour the descaler into the tank up to level A (corresponding to a 100 ml pack) marked on the inner surface of the tank (fig. 34), then add water (1 litre) up to level B (fig. 35) and put the water tank back. Press **Next >** ;
6. "EMPTY DRIP TRAY" (fig. 21):
7. Remove, empty and replace the drip tray (A15) and grounds container (A11). Press **Next >** ;
8. "POSITION 2L CONTAINER" "OK TO START":

Place an empty container of at least of 2 litres capacity under the hot water spout (D6) and coffee spouts (A9) ;

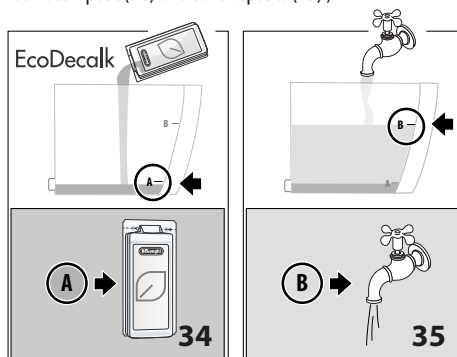

Important! Danger of scalding

Hot water containing acid flows from the hot water and coffee spouts. Accordingly, take care to avoid contact with this solution.

9. Press **Ok ✓** to confirm that the descaling solution has been added. "DESCALING UNDERWAY" "PLEASE WAIT" is displayed: the descale programme starts and the descaler solution comes out of the hot water spout and the coffee spout; a succession of rinses is performed automatically at

set intervals to remove the scale residues from inside the coffee machine;

After about 15 minutes, descaling stops;

10. "RINSE AND FILL WATER TANK UP TO MAX LEVEL" (fig. 3): the appliance is now ready for a process of rinsing with fresh water. Empty the container used to collect the descaler solution. Remove the water tank from the machine, empty it and rinse under running water, then fill with clean water up to the MAX level and reposition it in the machine.
11. "POSITION 2I CONTAINER OK TO START RINSING": Reposition the container used to collect the descaler solution, empty, under the coffee spouts and hot water spout and press **Ok ✓**;
12. Hot water is delivered first from the coffee spouts then from the hot water spout and the message "RINSING UNDERWAY, PLEASE WAIT" is displayed;
13. When the water in the tank has run out, empty the container used to collect the rinsing water;
14. (If the filter is installed) "INSERT FILTER IN ITS HOUSING" (fig. 36). Press **Next >** and take out the water tank: replace the water softener filter, if removed previously;

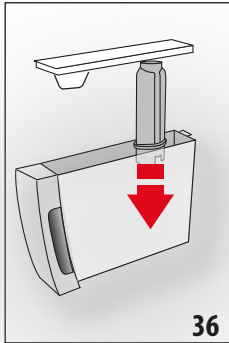

15. "RINSE AND FILL WATER TANK UP TO MAX LEVEL" (fig. 3): Fill the tank up to the MAX level with fresh water;
16. "INSERT WATER TANK" (fig. 4): Reposition the water tank in the machine.
17. "POSITION 2I CONTAINER" "OK TO START RINSING": Reposition the container used to collect the descaler solution, empty, under the hot water spout (fig. 8) and press **Ok ✓**.
18. Hot water is delivered from the hot water/steam spout and the message "RINSING UNDERWAY, PLEASE WAIT" is displayed;
19. "EMPTY DRIP TRAY" (fig. 21): At the end of the second rinse, empty the container used to collect the rinsing water, remove and empty the drip tray (A15) and grounds container (A11) and return them to the machine: press **Next >**;

20. "DESCALE COMPLETE": press **Ok ✓**;
21. "FILL TANK WITH FRESH WATER": remove and top up the water tank with fresh water to the MAX level and put back in the machine.

The descaling cycle is now complete.

Please note!

- If the descaling cycle is not completed correctly (e.g. electrical power failure), when power is restored the appliance will prompt for the cycle to be completed.
- Water may find its way into the grounds container (A11) during the descale cycle: this is quite normal.
- If the water tank has not been filled to the MAX level, at the end of descaling, the appliance requests a third rinse to guarantee that the descaler solution has been completely eliminated from the machine's internal circuits. Before starting the rinse, remember to empty the drip tray.

14. SETTING WATER HARDNESS

The descaling alert is displayed after a period of operation established according to water hardness.

The machine can also be programmed according to the actual hardness of the local water supply, so that the descaling procedure will be required less frequently.

14.1 Measuring water hardness

1. Remove the "TOTAL HARDNESS TEST" indicator strip (D1) from its pack.
2. Immerse the paper completely in a glass of water for about one second.
3. Remove the strip from the water and shake lightly. After about a minute, 1, 2, 3, or 4 red squares appear, depending on the hardness of the water. Each square corresponds to one level.

14.2 Setting water hardness

1. Access the menu as described in section "6.1 Access the menu";
2. Press "WATER HARDNESS";
3. Carry out the procedure described in the previous section to measure the water hardness;
4. "WATER HARDNESS" "CURRENT VALUE UNDERLINED": Press the level measured previously as indicated in the following table: (Level 1 = soft water; Level 4 = very hard water);

Indicator paper	Water hardness
	Level 1 - soft water
	Level 2 - slightly hard water
	Level 3 - hard water

Indicator paper	Water hardness
	Level 4 - very hard water

5. Press  to go back to the homepage.
The machine is now reprogrammed with the new water hardness setting.

15. WATER SOFTENER FILTER

Certain models come equipped with a water softener filter (D4): if this is not the case with your model, we would advise purchasing one from a De'Longhi approved service centre. To use the filter correctly, follow the instructions below.

15.1 Installing the filter

1. Access the menu as described in section "6.1 Access the menu";
2. Press "WATER FILTER";
3. "TURN DATE INDICATOR TO NEXT 2 MONTHS" (fig. 37): remove the new filter (D4) from the pack and turn the date indicator disk so that it shows the next 2 months of use. Press  ;

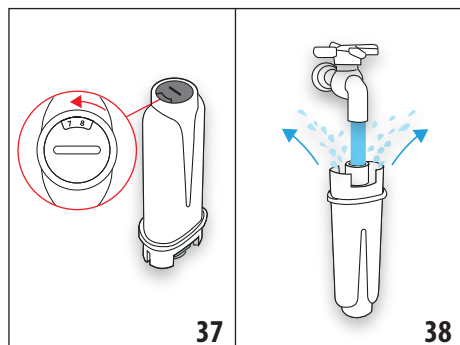

Please note



The filter lasts about two months assuming normal use of the machine; if on the other hand the machine remains idle with the filter installed, it will not last more than three weeks, at most.

4. "RUN WATER INTO FILTER HOLE" "UNTIL IT COMES OUT" (fig. 38): To activate the filter, run tap water through the central hole of the filter as shown in the figure until water comes out of the openings at the side for more than one minute. Press  ;
5. Extract the tank (A17) from the appliance and fill with water.
6. "IMMERSE FILTER TO RELEASE AIR BUBBLES" (fig. 39): Insert the filter in the water tank and immerse it completely

for about ten seconds, tilting it and applying light pressure so that the air bubbles can escape.

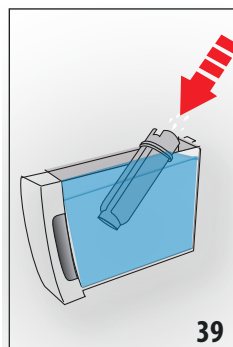
Press  ;



7. "INSERT FILTER" "IN HOUSING": Insert the filter (D4) in the filter housing (fig. 36) and press fully home. Press  ;
8. "INSERT WATER TANK": Close the tank with the lid (A16), then reposition the tank in the machine (fig. 4);
9. "POSITION 0.5L CONTAINER, OK TO ENABLE FILTER" (fig. 6): Place the container under the hot water spout (D6) and press  : "HOT WATER PLEASE WAIT" delivery starts and stops automatically.

The filter is now activated and the machine can be used.

15.2 Replacing the filter

Replace the filter (D4) when "REPLACE WATER FILTER" "PRESS OK TO START" appears on the display: to replace immediately, press  and follow the instructions from point 5 of the preceding section.

To delay replacement of the filter until later, press  .

The symbol  (B8) appears on the display as a reminder that the filter needs replacing. To replace, proceed as follows:

1. Access the menu as described in section "6.1 Access the menu";
2. Press "WATER FILTER";
3. Press "REPLACE FILTER"
4. First remove the tank (A17) and the spent filter, then follow the operations described in the previous section from point 3 onwards.

Please note!

After two months (see date indicator), or after 3 weeks if the appliance has not been used, the filter should be replaced even if the warning message has not yet been displayed.

15.3 Removing the filter

If the intention is to use the appliance without the filter (D4), its removal must be indicated in the machine settings. Proceed as follows:

1. Remove the water tank (A17) and the spent filter;
2. Access the menu as described in section "6.1 Access the menu";
3. PRESS "WATER FILTER";
4. Press "REMOVE WATER FILTER";
5. "CONFIRM FILTER REMOVL": press **Ok ✓** (or press **↩ Esc** to go back to the settings menu);
6. "FILTER REMOVED": the change has been saved. Press **Ok ✓** to go back to the homepage.

Please note!

After two months (see date indicator), or after 3 weeks if the appliance has not been used, the filter should be replaced even if the warning message has not yet been displayed.

16. TECHNICAL DATA

Voltage:	220-240V~ 50-60 Hz max. 10 A
Power:	1450 W
Pressure:	1.5 MPa (15 bars)
Water tank capacity:	1.8l
Size LxDxH:	240x440x360 mm
Cord length:	1250 mm
Weight:	10 kg
Beans container capacity:	300 g

16.1 Tips for Energy Saving

- To reduce energy consumption, after delivering one or more drinks, remove the container (E) or accessories.
- Set auto-off to 15 minutes (see section "6.11 Auto-off (standby) (⏸)");
- Enable Energy Saving (see paragraph "6.13 Energy saving (⏸)");
- When prompted by the machine, perform the descaling cycle (see section "13. Descaling").

17. DISPLAYED MESSAGES

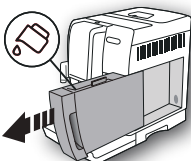
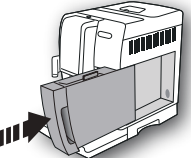
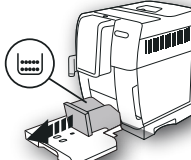
DISPLAYED MESSAGE	POSSIBLE CAUSE	REMEDY
<p>FILL TANK WITH FRESH WATER</p> 	Insufficient water in the tank (A17).	Fill the tank with water and/or insert it correctly, pushing it as far as it will go until it clicks into place.
<p>INSERT WATER TANK</p> 	The tank (A17) is not inserted or is inserted incorrectly.	Reposition the tank correctly and press fully home.
<p>EMPTY GROUNDS CONTAINER</p> 	The grounds container (A11) is full.	Empty the grounds container and drip tray (A15) then clean and return them to the machine. Important: when removing the drip tray, the grounds container must always be emptied, however little it may have been filled. If this is not done, it can happen that the grounds container will fill up more than expected when further coffees are prepared, causing the machine to clog.

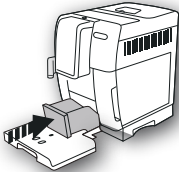
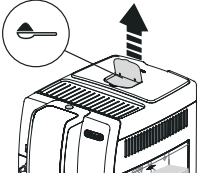
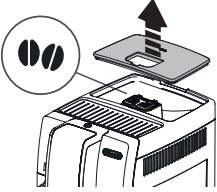
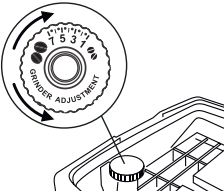

DISPLAYED MESSAGE	POSSIBLE CAUSE	REMEDY
<p>INSERT GROUNDS CONTAINER</p> 	<p>After cleaning, the grounds container (A11) has not been replaced.</p>	<p>Remove the drip tray (A15) and insert the grounds container.</p>
<p>ADD GROUND COFFEE MAX. ONE MEASURE</p> 	<p>Preparation with pre-ground coffee has been selected.</p>	<p>Make sure the funnel (A4) is not blocked, then add one level measure (D2) of pre-ground coffee, press "OK" on the display and follow the instructions in section "7.4 Making coffee using pre-ground coffee".</p>
<p>FILL BEANS CONTAINER</p> 	<p>The coffee beans have run out. The pre-ground coffee funnel (A4) is clogged.</p>	<p>Fill the beans container (A4) (fig. 10). Empty the funnel with the aid of the brush (D5) as described in section "12.8 Cleaning the pre-ground coffee funnel".</p>
<p>GROUND TOO FINE. ADJUST MILL</p> 	<p>The grinding is too fine, so that the coffee is delivered too slowly or not at all. If the water softener filter (D4) is present, an air bubble may have been released inside the circuit, obstructing delivery.</p>	<p>Repeat coffee delivery and turn the grinding adjustment dial (A5) (fig. 12) one click clockwise towards "7" while the coffee mill is in operation. If after making at least 2 coffees delivery is still too slow, repeat the correction procedure, turning the grinding adjustment dial another click until delivery is correct (see section "7.5 Adjusting the coffee mill"). If the problem persists, make sure the water tank (A17) is fully inserted. Insert the hot water spout (D6) in the appliance and deliver a little water until the flow becomes regular. If the problem persists, remove the filter (see section 15.3 Removing the filter).</p>
<p>INSERT WATER SPOUT</p>	<p>The hot water spout (D6) is not inserted or is inserted incorrectly</p>	<p>Insert the water spout and push fully home.</p>
<p>INSERT MILK CARAFE</p>	<p>The milk carafe (E) is missing or not correctly in place.</p>	<p>Insert the milk carafe and push fully home.</p>
<p>INSERT INFUSER ASSEMBLY</p>	<p>The infuser (A20) has not been replaced after cleaning.</p>	<p>Insert the infuser as described in section "12.9 Cleaning the infuser".</p>

DISPLAYED MESSAGE	POSSIBLE CAUSE	REMEDY
WATER CIRCUIT EMPTY PRESS OK TO START	The water circuit is empty	Press the selector corresponding to "OK" to deliver water from the spout (D6) until it flows out normally. If the problem persists, make sure the water tank (A17) is fully inserted.
	A new water softener filter has been inserted (D4)	Make sure the instructions for inserting the new filter have been followed correctly (section "15. Water softener filter"). If the problem persists, remove the filter (see section 15.3 Removing the filter).
PRESS OK TO CLEAN OR TURN DIAL	The milk carafe has been inserted with the froth adjustment dial (E1) in the CLEAN position.	To proceed with the CLEAN function, press the selector corresponding to "OK", or turn the froth adjustment dial to one of the milk positions.
DESCALING INTERRUPTED PRESS NEXT TO CONTINUE	Descaling has been interrupted or has not been completed correctly.	Press NEXT to resume the descaling procedure. For more information, see section "13. Descaling".
TURN MILK FROTH ADJUSTMENT DIAL TO CLEAN POSITION	Milk has been delivered recently and the tubes inside the milk carafe (E) must be cleaned.	Turn the froth adjustment dial (E1) to CLEAN (fig. 18).
TURN FROTH ADJUSTMENT DIAL	A recipe with milk was requested	Turn the dial to the required froth position.
SELECT A Milder TASTE OR REDUCE COFFEE QUANTITY	Too much coffee has been used.	Select a milder taste by pressing the "INTENSITY" button (C5) or reduce the quantity of ground coffee (maximum 1 measure).
DESCALING NEEDED PRESS OK TO START (~30MIN)	Indicates that the machine needs descaling.	Press the selector corresponding to "OK" to start descaling or "ESC" to descale later. The descaling procedure described in section "13. Descaling" needs to be performed.
REPLACE WATER FILTER PRESS OK TO START	The water softener filter (D4) is exhausted.	Press the selector corresponding to "OK" to replace or remove the filter, or "ESC" to carry out the procedure later. Follow the instructions in section "15. Water softener filter".

DISPLAYED MESSAGE	POSSIBLE CAUSE	REMEDY
GENERAL ALARM: REFER TO USER MANUAL	The inside of the appliance is very dirty.	Clean the inside of the appliance thoroughly, as described in section "12. Cleaning". If the message is still displayed after cleaning, contact De'Longhi customer services and/or an authorized service centre.
	Remember that the internal tubes of the milk carafe (E) must be cleaned.	Turn the froth adjustment dial (E1) to CLEAN (fig. 18).
	Reminds you the filter (D4) must be replaced.	Replace the filter or remove it as described in section "15. Water softener filter".
	The machine must be descaled.	The descaling procedure needs to be carried out without delay, see section "13. Descaling".
	Energy saving is enabled.	To disable energy saving, proceed as described in section "6.13 Energy saving 
PLEASE WAIT	The appliance is heating up to the optimum temperature	
CLEANING UNDERWAY PLEASE WAIT	The appliance has detected impurities in its internal circuits.	Wait for the appliance to be ready again and reselect the required drink. If the problem persists, contact De'Longhi Customer Services.

18. TROUBLESHOOTING

Possible malfunctions of the machine are listed below. If the problem cannot be resolved as described, contact Customer Service.

PROBLEM	POSSIBLE CAUSE	REMEDY
The appliance does not come on.	It is not plugged into the mains socket.	Plug into the mains socket (fig. 1).
	When present, make sure the main switch «A2» is on.	Press the main switch to the I position «fig. 1».
The coffee is not hot.	The cups were not preheated.	Warm the cups by rinsing them with hot water (Please note: the hot water function can be used).
	The internal circuits of the appliance have cooled down because 2/3 minutes have elapsed since the last coffee was made.	Before making the coffee, heat the infuser by rinsing using the rinse function (see section "6.3 Rinse  ").
	Coffee temperature setting too low.	Set a hotter coffee temperature in the menu (see section "6.7 Coffee temperature  "). Please note: Varying the temperature has most effect for long drinks.
	The machine needs descaling	Proceed as described in section "13. Descaling". Next, check the water hardness ("14.1 Measuring water hardness") and make sure the machine setting matches the local water supply hardness ("14.2 Setting water hardness").

PROBLEM	POSSIBLE CAUSE	REMEDY
The coffee is weak or not creamy enough.	Coffee ground too coarsely.	Turn the grinding adjustment dial (A5) one click anticlockwise towards "1" while the coffee mill is in operation (fig. 12). Continue one click at a time until coffee delivery is satisfactory. The effect is only visible after delivering 2 coffees (see section "7.5 Adjusting the coffee mill").
	Coffee not suitable.	Use coffee for espresso machines.
	Coffee not fresh.	The coffee pack has been opened for too long and has lost its taste.
The coffee emerges too slowly or drop-by-drop.	Coffee ground too finely.	Turn the grinding adjustment dial (A5) one click clockwise towards "7" while the coffee mill is in operation (fig. 12). Continue one click at a time until coffee delivery is satisfactory. The effect is only visible after delivering 2 coffees (see section "7.5 Adjusting the coffee mill").
Coffee does not come out of one or both spouts.	The coffee spouts (A9) are blocked.	Clean the spouts with a toothpick (fig. 24B).
The coffee delivered is watery.	The funnel (A4) is clogged.	Clean the funnel with the aid of the brush (D5) as described in section "12.8 Cleaning the pre-ground coffee funnel".
The appliance will not make coffee	The appliance has detected impurities in its internal circuits. "Cleaning underway" is displayed.	Wait until the appliance is ready for use again and reselect the required drink. Contact an authorized Service Centre if the problem persists.
The infuser cannot be removed	The appliance has not been turned off correctly	Turn the appliance off by pressing the  button (A7) (see section "5. Turning the appliance off").
With the descaling procedure completed, the appliance prompts for a third rinse	During the two rinse cycles, the water tank (A17) has not been filled to the MAX level	Follow the instructions displayed by the appliance, but first empty the drip tray (A15) to avoid the water overflowing.
Milk does not flow from the milk spout (E5)	The lid (E2) of the milk carafe (E3) is dirty	Clean the milk carafe lid as described in section "12.10 Cleaning the milk carafe".
	The lid (E2) is not correctly in place.	Assemble all the components correctly as indicated in section "9.1 Filling and attaching the milk carafe".

PROBLEM	POSSIBLE CAUSE	REMEDY
The milk presents large bubbles or splashes from the milk spout (E5) or is under-frothed.	The milk is not cold enough, or the type of milk not suitable for the drink requested	To ensure optimum results, check that the right type of milk is used when preparing hot drinks or cold drinks (see section "9.1 Che latte utilizzare?"). Use drinks at refrigerator temperature (about 5° C).
	The froth adjustment dial (E1) is incorrectly adjusted.	Adjust following the instructions in section "9. making hot milk-based drinks".
	The lid (E2) or the froth adjustment dial (E1) of the milk carafe are dirty	Clean the lid and adjustment dial of the milk carafe as described in section "12.10 Cleaning the milk carafe".
	There is water in the channel on the underside of the froth adjustment dial (E1),	Detach the dial and dry thoroughly.
	Vegetable drinks are being used.	For best results, use drinks at refrigerator temperature (about 5° C). Adjust the amount of froth as described in section "9.3 Adjusting the amount of froth"
	The hot water connection nozzle (A8) is dirty	Clean the connection nozzle as described in section "12.11 Cleaning the hot water nozzle".
The machine emits noises or small puffs of steam while not in use	The machine is ready for use, or has recently been turned off, and condensate is dripping into the hot vaporiser	This is part of normal operation. To limit the phenomenon, empty the drip tray.
The cup shelf (A12) is hot.	Several drinks have been prepared in rapid succession	
After cleaning, the drip tray (A15) cannot be put back in the machine	The condensate tray(A10) is not in the correct position	Make sure the condensate tray is inserted correctly
The appliance emits puffs of steam from the drip tray (A15) and/or there is water on the surface the appliance rests on.	The drip tray grille (A14)has not been replaced after cleaning.	Reposition the grille in the drip tray.

Register Now 
www.delonghi.com/register

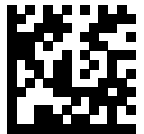

De'Longhi Appliances via Seitz, 47 31100 Treviso, Italy www.delonghi.com

5713268236_00_0723